

BAHAMA®

Jumbrella & Jumbrella Wave



Sturdy...

BAHAMA®

The Heart of it All

Jumbrella is the solution for everything. It can be found in our product range between »small and light« like the models Easy and Event and »large« like the models Jumbrella XL, Largo & Magnum. The large-size parasol Jumbrella stands out with its numerous possible combinations and additional features. The different features can be individually combined depending on your technical requirements.

- * 20 different model sizes from 8 m² to 36 m² and side lengths from 2 to 6 m
- * Round, square and rectangular models
- * Great variety of additional features e.g. textile gutters, side panels, lighting with LED, heating, speakers, TV, Wifi, extra protection with the V4A | Maritime Edition
- * Maintenance-free servo mechanism for trouble-free opening and closing
- * Energy efficient handling through gradual opening (servo-mechanism); depending on model 2- or 4-stages
- * No loose functional parts like ropes, cranks or connectors
- * 2 lockable handles with spring buckles for optimal fabric tension
- * Standard frame in traffic white | RAL 9016, glossy finish or in anthracite grey | RAL 7016, textured matte finish
- * Optional custom design of frame finish (color, exclusive wood look | Golden Oak) and of membranes
- * Perfect, lasting tension as the textile membrane is integrated into the spoke
- * Additional, stabilizing support spokes
- * Membranes made of 100% polyester in three different high-quality fabrics
- * Large, contemporary selection of colors
- * Highest UV-protection UPF 50+
- * Absolutely waterproof
- * Numerous possibilities for printing on the textile membranes and/or valances
- * Including protective cover with lacing, made of tent fabric | Nicotarp
- * Short delivery times, fast spare parts delivery, lifelong spare parts supply
- * Various installation options as well as adaptations for various on-site conditions (either fixed or tiltable)
- * Newest generation of infrared radiators that can remain in the closed parasol
- * Integrated theft prevention
- * Up to 111-months wind warranty depending on installation options and parasol size of up to wind force 10 | 102 km/h

Bahama

Founded in 1950 today Bahama designs and manufactures a great variety of high-quality large-size parasols and sun sails. National and International customers alike trust in our industrial technology and accurate workmanship. The premium products from Bahama characteristically stand for technical attributes like compactness, durability and wind stability but also for aesthetical features like beautiful designs and materials.

»Made in Germany« – our full range production facility manufactures nearly all parts in house. Bahama further processes sustainable and environmentally friendly materials according to the OEKO-TEX 100 standard, Class 1. The combination of high-quality materials and the structural features allows Bahama to guarantee wind stability for its products, depending on the model, of up to 130 km/h.

And most importantly: we love customer service – from consulting to installation, from cleaning to winter storage and maintenance.

Discover the possibilities of an extended outdoor season. No matter what the weather. Just get to know us!



reddot design award
winner 2018

The Jumbrella 4 x 4 m wins the iF DESIGN AWARD 2018 and the Red Dot Award 2018. Both awards, which are among the most acclaimed prizes for great designs since the 1950s, will be handed out separately. The independent international jury of experts awarded the coveted quality label among more than 6,000 submissions from over 50 countries.



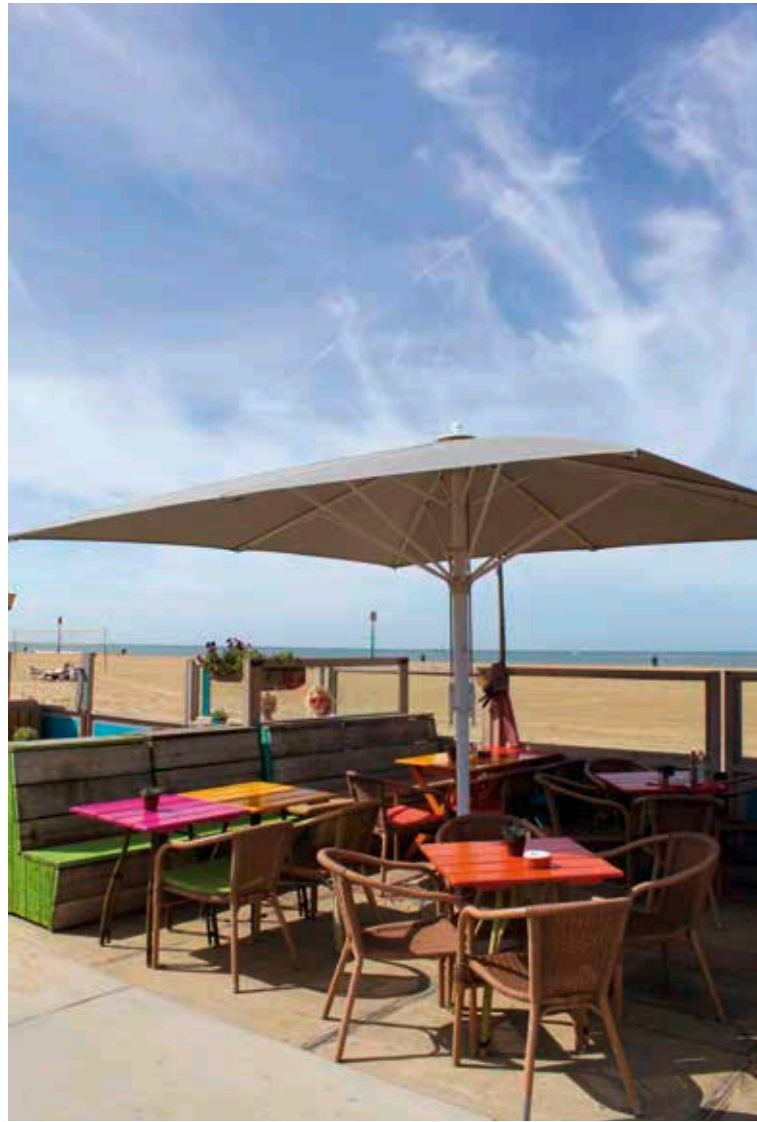

Product Information

1 Textile Membranes

No matter your choice of fabric, the resulting textile membranes combine all the attributes of a durable and sustainable product. These include next to the high-quality appearance numerous technical functions.

1.1. Brand Name: betex®05 | Fabric exclusively crafted for Bahama

100% polyester fabric with top transparent coating

Grammage of approx. 200 g/m²

Highest sun protection factor UPF 50+, protects against harmful UV radiation (exception: snow 9577)

High degree of fabric lightfastness (i.e. fading) (DIN EN ISO 105-B02 Class ≥ 6-7)

High waterproofness, pressure resistance (DIN EN 20811, ISO 811 | Water column ≥ 100 mbar, 1.000 mm)

Low moisture absorption, dries quickly

High temperature resistance (DIN 53361 from -30°/+90°C)

Excellent friction resistance (DIN EN ISO 105-x12 | Class ≥ 4-5)

High tear resistance due to high thread count

Durable, tailor-made and dimensionally stable with perfect membrane tension

Sustainable and environmentally friendly fabrics with the OEKO-TEX 100 Standard, Class 1

Exchangeable and washable one-piece membranes

25 contemporary colors (custom colors upon request)

Printable with the most modern printing process



1.2. Brand Name: TEXOUT Precontraint 302

100% polyester fabric 550 Dtex

With vinyl coating

Grammage of approx. 480 g/m²

Highest sun protection factor UPF 50+, protects against harmful UV radiation

Highest degree of fabric lightfastness (i.e. fading) (DIN EN ISO 105-B02 | Class ≥ 7-8)

Heat-sealed segments, 100% waterproof

High temperature resistance (DIN 53361 from -30°/+70°C)

Fire retardant (DIN 4102-B1)

Exceptional surface stability and tear resistance

Durable, robust, dirt-repellant and stable in all weather conditions

Own cleaning possibility due to increased dirt accumulation through leaves, tree sap, bird-droppings, car exhaust or dust

Recyclable

25 contemporary colors (custom colors upon request)

Printable with the most modern printing process



1.3. Brand Name: swela Sunvas

100% polyester fabric with dirt and water repelling impregnation

Grammage of approx. 310 g/m²

Highest sun protection factor UPF 50+, protects against harmful UV radiation

Highest degree of fabric lightfastness (i.e. fading) (DIN EN ISO 105-B02 | Class ≥ 7-8)

High waterproofness, pressure resistance (EN 20811, ISO 811 | Water column ≥ 35 m bar, 350 mm)

Weather fastness (DIN EN ISO 105-B04 | Class ≥ 7-8)

Excellent friction resistance (DIN EN ISO 105-x12 | Class ≥ 4-5)

High tear resistance

Distinctive surface feel

Not printable

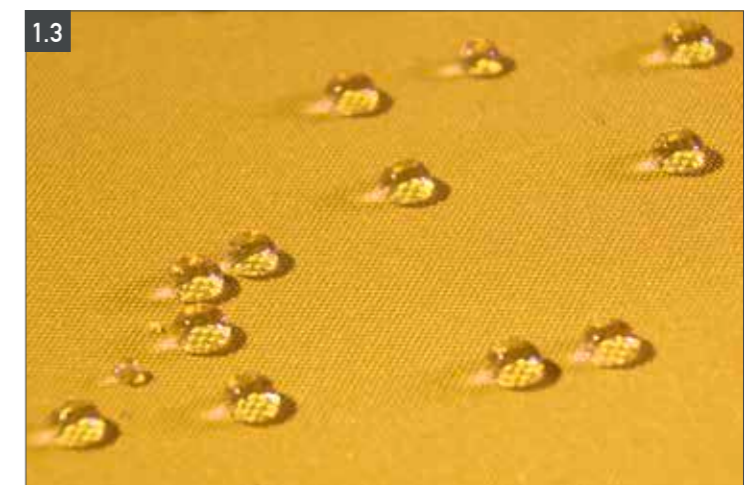

Product Information



2 Umbrella Frame

The difference may not be obvious at first sight: but the large-size parasols from Bahama have an inner and an outer pole that optically come together to form one center pole. Better sturdiness also means better stability and the corresponding safety.

Center pole with Outer and Inner pole

Easy and quick opening and closing due to the maintenance-free servo-mechanism

Easy and efficient handling through gradual opening (servo-mechanism); depending on model 2- or 4-stages (picture 2.1)

Tension latches with spring buckles for opening and closing instead of a crank

Extra stability through extruded, internally strengthened and profiled aluminum center pole (picture 2.2)

Pole diameter approx. 80 mm, wall thickness approx. 2.5 mm

Impact and scratch resistant due to PES powder-coated center pole, post-baked

Standard frame in traffic white | RAL 9016, glossy finish or in anthracite grey | RAL 7016, textured matte finish (picture 2.3 + 2.4)

Optional custom design for frames (color, exclusive wood look | Golden Oak) and membranes (picture 2.5)

Cylindrical locks in the handles prevent unauthorized opening and closing (picture 2.1)

OPTIONAL

Umbrella center pole extension, up to 50 cm are possible depending on model

Umbrella center pole reduction (upon request)

Spokes, Support Spokes, Bearings and Hinges

The quality of a parasol can only be as good as its supporting and connecting parts.

Welded rectangular aluminum profile using special alloy Al F30/32; no sharp edges

Mounted using stainless steel axle bolts and spring pins (picture 2.6)

No plastic parts used

With hollow seam for spoke membrane integration

Individually exchangeable spokes and support spokes

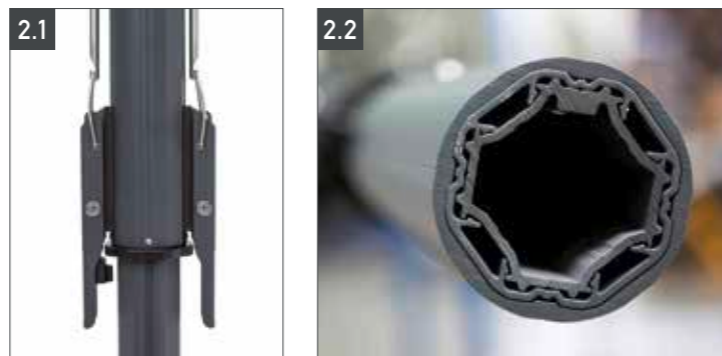

3 Installation Options

There is a choice of mobile or permanent installation options. Mobile installation is characterized by a greater degree of flexibility in choosing the location and surface. When installing an in-ground option, building measures must be carried out that have to be taken into consideration during the planning phase. They consist of above-ground and in-ground pieces to be set in concrete.

3.1. Mobile Installation Options

I. Portable Stand

Hot-dip galvanized and powder-coated steel frame

Including aesthetically designed, bright deco concrete slabs

Height adjustable in all 4 corners; standard

Weight: approx. 160 - 460 kg depending on size

For use with changing locations

II. Cross-Frame

Hot-dip galvanized steel frame

For 8 or 12 standard flagstones
500 × 500 × 50 mm (not included in the price)

Size of cross-frame: approx. 1130 × 1130 mm

Weight of cross-frame: approx. 28 kg for 8 flagstones, approx. 30 kg for 12 flagstones

OPTIONAL

Powder-coating in RAL color of parasol frame

Height adjustable in all 4 corners (picture II.1)

III. Steel Plate Base with 4 or 8 Steel Plates | 2 Layers

Flat construction with only 15 mm installation height; no tripping hazard

Hot-dip galvanized plates

Tiltable screw-on receiving column

Plate size: 490 × 490 × 15 mm (ea. 28 kg)
or 740 × 740 × 15 mm (ea. 65.2 kg)

OPTIONAL

Powder-coating in traffic white | RAL 9016, glossy finish or in anthracite grey | RAL 7016, textured matte finish in (picture III.1) and/or in RAL color of the parasol frame

Spacer height min. 150 mm - max. 350 mm or starting at a height of 351 mm e.g. for terrace substructures. (picture III.2)



Sizes of the portable stands for picture I.

| | |
|--------------------------------------------------------|--------------------------------|
| for 3 × 3 m | 850 × 850 mm, approx. 160 kg |
| for ø 4 m 3.53 × 3.53 m | 1000 × 1000 mm, approx. 190 kg |
| for ø 4.5 m 4 × 2 m 4 × 3 m 4 × 4 m | 1000 × 1000 mm, approx. 240 kg |
| for ø 5 m 4.5 × 4.5 m 5 × 2.5 m 5 × 3 m | 1000 × 1000 mm, approx. 290 kg |
| for ø 5.6 m 5 × 5 m 5 × 3.75 m 5 × 4 m 6 × 3 m | 1200 × 1200 mm, approx. 380 kg |
| for ø 6.3 m ø 7 m 6 × 4 m 6 × 4.5 m | 1200 × 1200 mm, approx. 460 kg |



Sizes of the Steel Plate Bases for picture III. and III.1

| | |
|-------------------------------------------------------------------------------------------------|----------------------------------------------------------|
| for ø 4 m ø 4.5 m 3 × 3 m 3.53 × 3.53 m 4 × 4 m 4 × 2 m 4 × 3 m | 2 layers, 8 plates, 490 × 490 × 15 mm, approx. 237 kg |
| for ø 5 m 4.5 × 4.5 m 5 × 2.5 m 5 × 3 m | 1 layer, 4 plates, 740 × 740 × 15 mm, approx. 290 kg |
| for ø 5.6 m ø 6.3 m ø 7 m 5 × 5 m 5 × 3.75 m 5 × 4 m 6 × 3 m 6 × 4 m 6 × 4.5 m | 2 layers, 8 plates, 740 × 740 × 15 mm, approx. 546 kg |



Product Information



3 Installation Options

3.2. Permanent Installation Options

I. In-Ground Sleeve

Sleeve to be set in concrete

Powder-coated above-ground connecting components

Weight: approx. 6 kg

For parasols with/without electro-mechanical features (except heating)

II. 3-Piece In-Ground Installation

Lower part to be set in concrete

Powder-coated above-ground connecting components with tilting hinge

Powder-coated center pole sleeve

Weight: approx. 4.8 kg

For parasols with/without electro-mechanical features (except heating)

OPTIONAL

In-ground installation extension for bridging a gap e.g. an installation in a kindergarten sandbox; height order-based starting at min. 150 mm to 400 mm; fulfills DIN EN 1176 (picture II.1)

III. Octagonal Surface Mount

Hot-dip galvanized and powder-coated steel

Receiving column is welded onto surface mount

Weight: approx. 18 kg

Especially suited for bolting onto massive timber planks

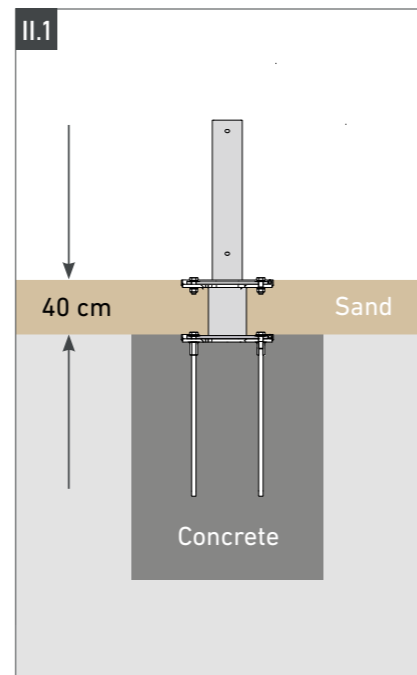

IV. Octagonal Surface Mount with Counter-Bores

Hot-dip galvanized and powder-coated steel

Powder-coated receiving column is welded on to surface mount

Weight: approx. 18 kg

Especially suited for bolting onto massive concrete surface

OPTIONAL

»fischer« heavy-duty anchoring bolts (1 set =8 pcs.); type #FH II 15/15 SK A4; M10 thread; incl. concrete drill type #SDS Plus II, drill depth 105 mm and Allen wrench SW 6

V. Dual Mounting Console (order-related)

Combination of in-ground sleeve and octagonal surface mount

Height: min. 140 mm - max. 350 mm (custom dimensions upon request)

Weight: approx. 24 kg

With integrated theft prevention and winter cover plate

Also available for umbrellas with electromechanical features and heating

VI. Connecting Plate for »Krinner« Ground Screw

Suitable for »Krinner« KSF F 140x2100-M no setting in concrete, screw-in foundation (picture VI.1)

Rigid, galvanized

Powder-coated receiving column

Weight: approx. 6.5 kg

OPTIONAL

With tilting hinge made of uncoated steel; weight: approx. 9 kg

Coating of the connecting plate in traffic white | RAL 9016, glossy finish or in anthracite grey | RAL 7016, textured matte finish

Especially suited for loose surfaces, e.g. kindergarten sandboxes

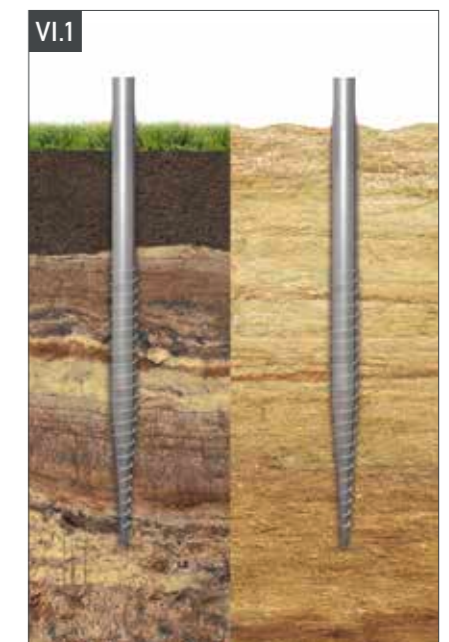

Product Information



4 Installation options for Parasols WITH Electrical Connection and/or Heating Option

A mobile or permanent installation option has to fulfill further requirements when the large-size parasol includes additional features like lighting, TV or heating: stability, invisible cable runs, protection against overheating, pre-assembly and much more. The interfaces between the actual large-size parasol and the additional features are precisely aligned to guarantee smooth operation. This results in each additional feature having its own technical requirements.

4.1. Mobile Installation Options

I. I. Portable Stand for Parasols WITH Heating

Hot-dip galvanized and powder-coated steel frame

Including aesthetically designed, bright deco concrete slabs

Height adjustable in all 4 corners; standard

For use with changing locations

Weight: approx. 160 – 460 kg depending on size

Including modification for parasols with radiators; with water-resistant 10-pole »Procon/Han« coupling plug and socket suitable for connecting to on-site cable; type H07 RN-F 12G1.5

II. Cross-Frame for Parasols WITH Heating

Hot-dip galvanized steel frame

For 8 or 12 standard flagstones
500 × 500 × 50 mm (not included in the price)

Size of cross-frame: approx. 1130 × 1130 mm

Weight of cross-frame: approx. 28 kg for 8 flagstones, approx. 30 kg for 12 flagstones

Including modification for parasols with radiators; with water-resistant 10-pole »Procon/Han« coupling plug and socket suitable for connecting to on-site cable; type H07 RN-F 12G1.5

Only available for height adjustable cross-frame models

OPTIONAL

Powder-coating in RAL color of the parasol frame



Sizes of the portable stands for picture I.

| | |
|--------------------------------------------------------|--------------------------------|
| for 3 × 3 m | 850 × 850 mm, approx. 160 kg |
| for ø 4 m 3.53 × 3.53 m | 1000 × 1000 mm, approx. 190 kg |
| for ø 4.5 m 4 × 2 m 4 × 3 m 4 × 4 m | 1000 × 1000 mm, approx. 240 kg |
| for ø 5 m 4.5 × 4.5 m 5 × 2.5 m 5 × 3 m | 1000 × 1000 mm, approx. 290 kg |
| for ø 5.6 m 5 × 5 m 5 × 3.75 m 5 × 4 m 6 × 3 m | 1200 × 1200 mm, approx. 380 kg |
| for ø 6.3 m ø 7 m 6 × 4 m 6 × 4.5 m | 1200 × 1200 mm, approx. 460 kg |

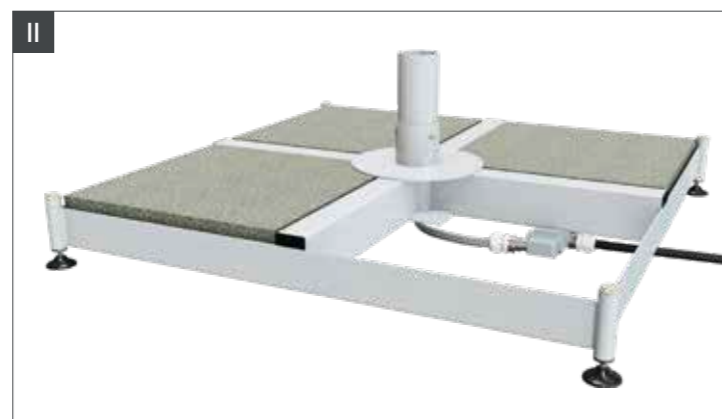

III. Steel Plate Base with 4 or 8 Steel Plates WITH Electrical Connection and/or Heating

Flat construction with only 15 mm installation height; no tripping hazard

Hot-dip galvanized plates

Tiltable screw-on receiving column

Plate size: 490 × 490 × 15 mm (ea. 28 kg)
or 740 × 740 × 15 mm (ea. 65.2 kg)

Only possible with corresponding spacer
(picture II.2 for parasol with radiator)

For version with heating, electric terminal is included
OPTIONAL

Powder-coating in traffic white | RAL 9016, glossy finish or in anthracite grey | RAL 7016, textured matte finish in (picture III.1) and/or in RAL color of the parasol frame

Spacer height min. 150 mm – max. 350 mm or starting at a height of 351 mm e.g. for terrace substructures
(picture III.2)

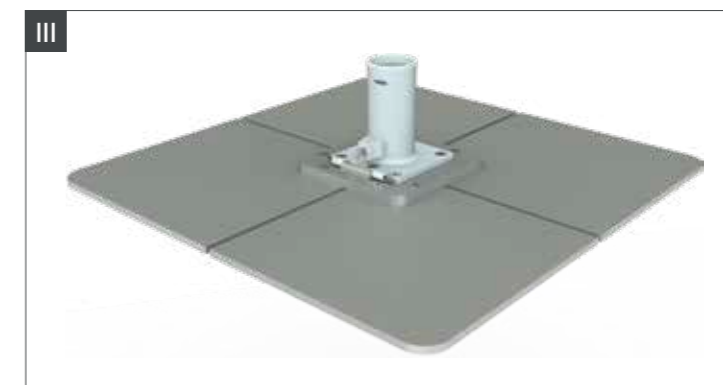

Product Information



4 Installation Options for Parasols WITH Electrical Connection and/or Heating

4.2. Permanent Installation Options

I. In-Ground Sleeve for Parasols WITH Heating

Sleeve to be set in concrete, flush-mounting

Above-ground, powder-coated connecting components

Electric terminal included

Weight: approx. 11 kg
(in-ground sleeve suitable for heating option)



II. 3-Piece In-Ground Installation WITH Heating

Lower part to be set in concrete

Powder-coated above-ground connecting components with tilting hinge

Powder-coated center pole sleeve

Electric terminal box included

Weight: approx. 15 kg
(in-ground sleeve suitable for heating option)



5 Transport Packaging

The parasols leave our production facility in perfect condition. To ensure they arrive in perfect condition they are delivered in a hard-cardboard cylinder tube.

Outer diameter approx. 362 to 462 mm

Cylinder length approx. 3.600 to 4.180 mm

Weight without parasol approx. 20-30 kg

**depending on model*

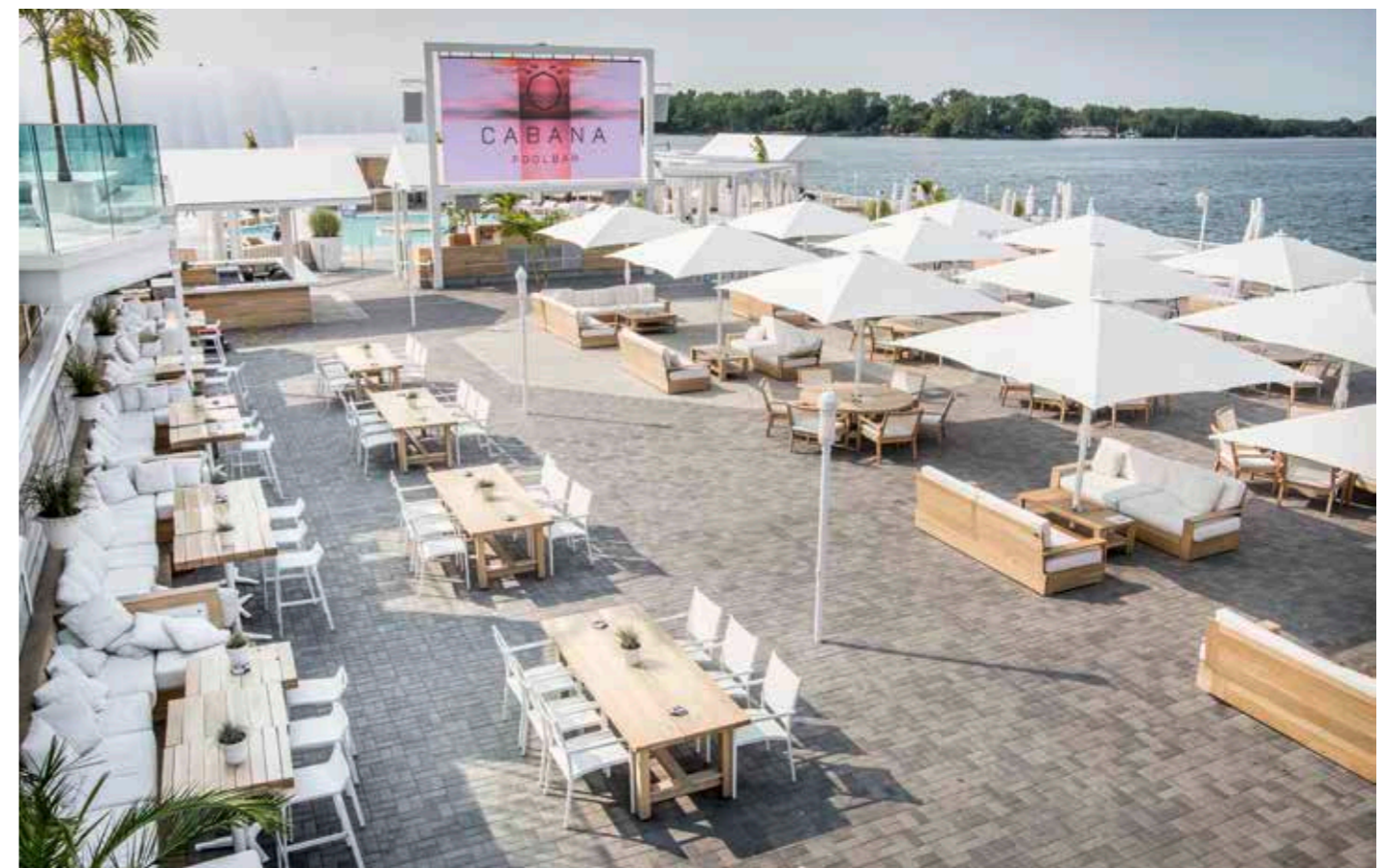

Additional Features



1 Valance

The valance is hemmed, dyed in the matching color and the edgelines are thermally processed. No ruffles here.

Valance height approx. 30 cm

Additional advertising space

2 Printing

The Bahama UV printer uses 9 color channels. Even pure white. Only lightfast and highest quality inks are used to ensure color accurate fonts, logos and emblems are positioned with millimeter precision. The membrane segments are sewed together after printing; the PVC-coated segments are heat sealed together.

No fading due to highly UV-resistant colors

Optimal advertising impact

Individual printing of the textile membranes

References: Mc Donalds, Starbucks, Heineken, Carlsberg, Bitburger, Gaffel, Café & Bar Celona, Café Extrablatt, Hilton, Kempinski et al

3 Extra Protection V4A | Maritime Edition

Optional off-shore stainless steel version »maritime«. Cannot be retrofitted.

All metal components made of a special alloy V4A stainless steel

Developed for use near the seaside

Especially durable



4 Textile Gutters

Not only rain falls from the sky, bird droppings or wet leaves are often bothersome, too. To attain one entirely closed area the individual parasols can be connected by a textile gutter creating a coherent covering that is optically appealing.

Gutter with a gradient for water runoff

Fastening with carabiners and chains

Stability due to rods inserted into the hollow seams

Colors matching the textile membrane

Optically appealing unit of parasol and gutter

Light-permeable for a cozy atmosphere

High waterproofness

Protection against rain, bird droppings and leaves

Frame Modification

The modification of the parasol frame is necessary (all spokes); threaded sockets are embedded in the spoke profile

Choice of Fabrics

betex®05, TEXOUT Precontraint 302, swela Sunvas

5 Protective Cover

Not only does it keep everything together, it also keeps it clean. Film packaging is often not enough protection. To this end there are – especially for winter or long-term storage – robust protective covers in different versions.

Protective Cover basic

Light weather protection cover (picture 5.1)

Tent fabric | Nicotarp with lacing

Included with the delivery of a new parasol

Protective Cover comfort

Robust weather protection cover (picture 5.3)

betex®05« | Polyester | 9801 - concrete

With zipper for telescopic rod

Protective Cover comfort with Telescopic Rod

Equipped with a telescopic rod (picture 5.2). When ordering more than one cover, only one telescopic rod is necessary

Easy to put over the parasol



Additional Features



6 Side Panels

There is no more tossing a coin to figure out who has to sit at the edge of the parasol when the weather isn't behaving. The quickly and easily unrolled »side panels« not only protect you from sudden rain showers, but also against the cold and wind. Through this possibility of creating a boundary, they provide a feeling of secure comfort.

Made completely of textile fabric with or without flexible windows of 0.5 mm strong Polyglass (picture 6)

With zipper for opening and closing (picture 6.1)

High waterproofness

Stability due to rods inserted into the hollow seams

Drip edge on the ground made of PVC-coated polyester fabric (picture 6.2)

Quick and easy to use; just hook it in (picture 6.3)

Light-permeable for a cozy atmosphere

Protection against sun, rain, wind and the cold

Temporary room solutions for individual event e.g. weddings, street parties, company festivities or to create a smoking area

Visual protection for unsightly surroundings like storage areas, clutter in the neighborhood, structural defects etc.

Protected seating area

Keeps a constant temperature of ambient air, especially in combination with heating radiators

Frame Modification

The modification of the parasol frame is necessary (per spoke); pre-fitting of eye screws and slot nuts on spoke profile (no additional drill hole)

OPTIONAL

Connecting piece for joining the side panels of 2 parasols (picture 6.4)

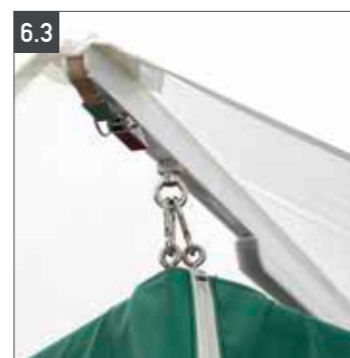
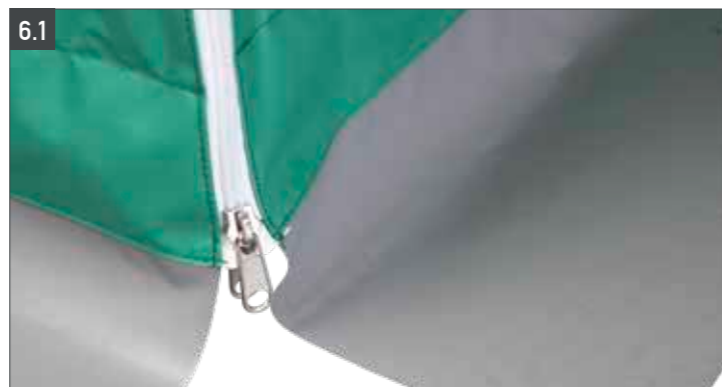

7 Impact Protection

Metal or soft padding? Some questions answer themselves when it comes to eliminating a potential source of injury (e.g. kindergartens or retirement homes).

Colorful soft foam safeguard; available in 10 colors

Cuff with soft foam on the inside

Outer material made of polyester fabric with vinyl coating

With Velcro fasteners



8 Theft Protection and Authorized Use

You wouldn't park your high-end bicycle without locking it up first, right? Protect your parasol from theft with a lock that is incorporated in the installation option. Two additional cylindrical locks in the handles prevent unauthorized use (opening and closing) of the parasol.

Lock in Handle (included with delivery)

1 Cylindrical lock per handle

Prevention of unauthorized opening and closing

Easy to use

Further Lock (included with delivery)

Theft protection

Incorporated in the installation option



Additional Features



9 Lighting | LED Lighting

There are moments when time flies by. The sun was just shining and now twilight has set in. The »light« installed in the parasol creates a uniform and pleasant atmosphere, that turns the night into day and lets you forget the time.

Economical energy consumption, due to LED light bulbs or LED strips

All wiring is inside; no tangled cables

Appealing lighting condition extends outdoor season

Creates a warm and inviting atmosphere

Pleasant working atmosphere for service personnel

Lighting

4 LED light bulbs

Light temperature 2700 K

4 × 4 W light power

supply power 240 V
(available in US edition - 120 V)

OPTIONAL

External control unit with FI-switch and on/off switch for each individual electromechanical option

LED-Lighting

RGB LED strips

Indirect RGB LED lighting 120-240/24V

Dimmable with remote control

Integrated into parasol spokes

Color sequences | 8 pre-programmed colors, including warm and cold white

OPTIONAL

2, 4, 6 or 8 RGB LED strips

External control unit with FI-switch and on/off switch for each individual electromechanical option



10 Heating

The »radiator« creates pleasant warmth by emitting infrared rays – without any pre-heating. When several are installed they can also be individually turned on or off. Even a cold ambient temperature is not perceived as unpleasant due to the direct warmth people feel. Use our heating option to defy frosty seasons and cool evenings.

Extended outdoor season; year-round outdoor living

2 or 4 electrical, turnable infrared radiators
(available in US edition)

Remote control can regulate 6 levels

2000 watts per radiator

Long-lasting »Ultra Low Glow« heating tube

Can remain in closed parasol

OPTIONAL

External control unit with FI-switch and on/off switch for each individual electromechanical option

2 or 4 infrared radiators



11 Speakers

Music is much more than just an acoustical backdrop. An installed »audio system« can create very different atmospheres, in which people can have a lively celebration or simply relax after work – depending on desire and mood.

Audio system integrated into the frame

Optionally with one or two speakers

OPTIONAL

External control unit with FI-switch and on/off switch for each individual electromechanical option

12 TV

Who likes sitting alone at home in front of the TV? Especially not when everyone is outdoors watching the same thing. The additional feature »TV« gives outdoor screening a community spirit with a great deal of fun.

Stable, light-weight mount

Installation for 1 or 2 screens per parasol

Frame Modification

Standard TV mounting console in parasol with VESA-Norm 200 for a maximum screen size of 32 inches (picture 12)

240 V power connection for 1 or 2 TVs on the mounting console (available in US edition - 120 V)

Network connection CAT 7 inside the electric crown unit

OPTIONAL

External control unit with FI-switch and on/off switch for each individual electromechanical option

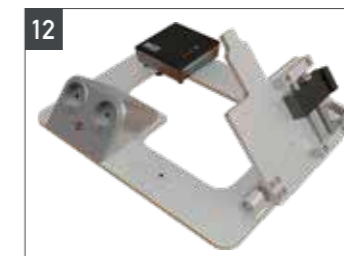

13 Wifi

These days it already seems a matter of course that customers are offered free public Wifi. Installing a »Wifi Network« is not merely providing an additional service, it also attracts and keeps customers.

Internal CAT 7 wiring

Integrated CAT 7 RJ45 network interface

Integrated in electrical crown unit

OPTIONAL

240 V-socket integrated in electrical crown unit
(available in US edition - 120 V)

Wifi device

External control unit with FI-switch and on/off switch for each individual electromechanical option

Handling

Opening, tensioning and closing is quick and easy.

OPENING

- Take off the safety strap. Lift the ends of the spokes until the parasol opens by itself.
- Latch in the spring buckle and press down on the handle. (picture 1).

CLOSING

- Lift handles up and unlatch the spring buckle.
- After completely closing the parasol (final position) Press handles down onto the pole (passive position).
- Pull the tips of the fabric to the outside of closed parasol and spirally wrap them around the center pole (picture 2).
- Wrap the safety strap around the parasol (picture 3).

The excellent appearance and the technical features of the textile membrane can be maintained by adhering to the following closing procedures:

Always pull the tips of the fabric to the outside of a closed parasol

Do not store the parasol with any fabric stuck between the spokes and support spokes





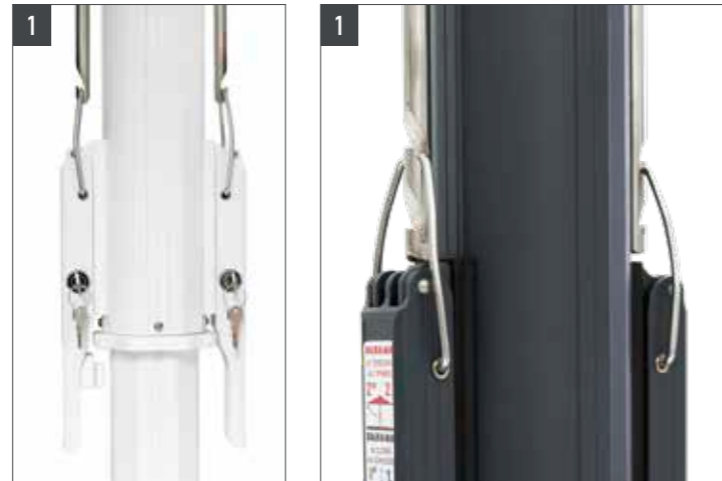

Spirally wrap the fabric around the center pole



Wrap the safety strap around the parasol to secure the fabric.











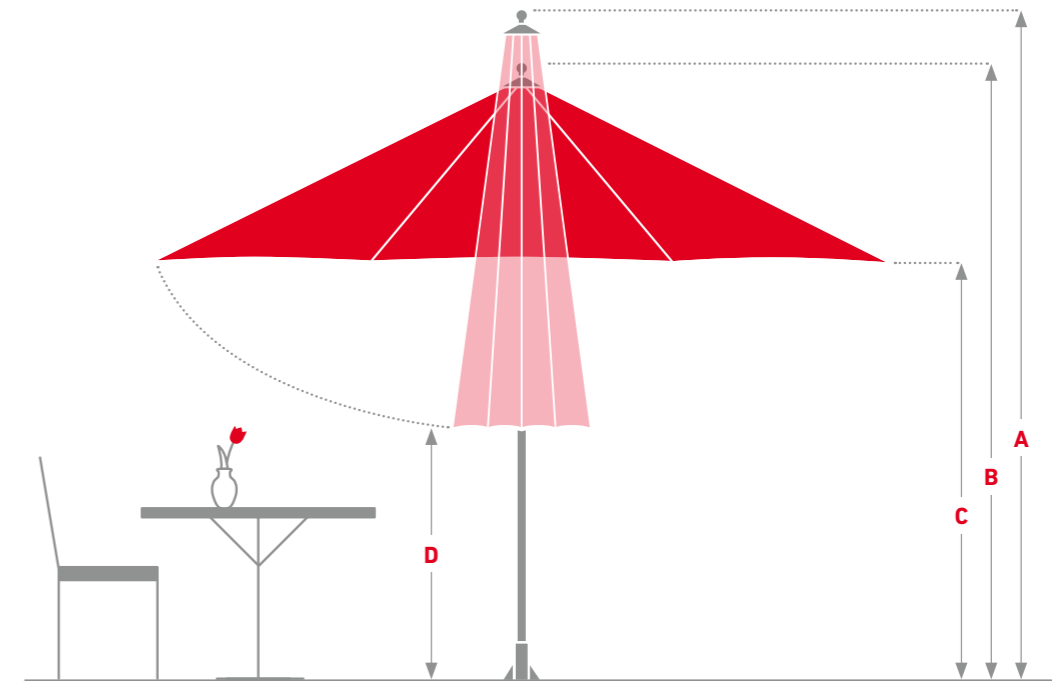

Dimensions & Technical Data

Jumbrella

| |  Ø 4.0 m 8 Spokes |  Ø 4.5 m 8 Spokes |  Ø 5.0 m 8 Spokes |  Ø 5.6 m 8 Spokes |  Ø 6.3 m 8 Spokes |  Ø 7.0 m 8 Spokes |
|------------------------------------------------------------------------------------------------|-------------------------------------------------------------------------------------------------------|-------------------------------------------------------------------------------------------------------|-------------------------------------------------------------------------------------------------------|-------------------------------------------------------------------------------------------------------|---------------------------------------------------------------------------------------------------------|---------------------------------------------------------------------------------------------------------|
| All measurements are approximate | | | | | | |
| Model No. | C 3040 | C 3045 | C 3050 | C 3056 | C 3063 | C 3070 |
| Area in m ² | 12 | 15 | 19 | 24 | 29 | 36 |
| Parasol weight <small>Without installation component & packaging, in kg</small> | 35 | 40 | 54 | 65 | 72 | 99 |
| Transport weight <small>incl. packaging, in kg</small> | 55 | 60 | 74 | 85 | 97 | 124 |
| A Height closed* in cm | 375 | 385 | 385 | 387 | 426 | 446 |
| B Height opened* in cm | 302 | 311 | 311 | 316 | 352 | 372 |
| C Passage height** in cm | 230 | 230 | 227 | 227 | 245 | 253 |
| D Ground clearance*** in cm | 135 | 140 | 120 | 90 | 95 | 85 |
| Max. permitted wind velocities <small>fully opened parasol, km/h Permanent/Mobile</small> | 95/71 | 95/71 | 88/66 | 74/56 | 48/36 | 38/29 |

| |  3.0 × 3.0 m 8 Spokes |  3.53 × 3.53 m 8 Spokes |  4.0 × 4.0 m 8 Spokes |  4.5 × 4.5 m 8 Spokes |  5.0 × 5.0 m 8 Spokes |
|------------------------------------------------------------------------------------------------|-----------------------------------------------------------------------------------------------------------|-------------------------------------------------------------------------------------------------------------|-----------------------------------------------------------------------------------------------------------|-------------------------------------------------------------------------------------------------------------|-------------------------------------------------------------------------------------------------------------|
| All measurements are approximate | | | | | |
| Model No. | C 3130 | C 3135 | C 3140 | C 3145 | C 3150 |
| Area in m ² | 9 | 12 | 16 | 20 | 25 |
| Parasol weight <small>Without installation component & packaging, in kg</small> | 39 | 43 | 50 | 57 | 84 |
| Transport weight <small>incl. packaging, in kg</small> | 59 | 63 | 70 | 77 | 109 |
| A Height closed* in cm | 375 | 385 | 375 | 385 | 401 |
| B Height opened* in cm | 301 | 311 | 311 | 311 | 331 |
| C Passage height** in cm | 229 | 226 | 231 | 230 | 240 |
| D Ground clearance*** in cm | 150 | 119 | 80 | 54 | 38 |
| Max. permitted wind velocities <small>fully opened parasol, km/h Permanent/Mobile</small> | 102/77 | 95/71 | 88/66 | 74/56 | 74/56 |



| |  4.0 × 2.0 m 8 Spokes |  4.0 × 3.0 m 8 Spokes |  5.0 × 2.5 m 8 Spokes |  5.0 × 3.0 m 10 Spokes |  5.0 × 3.75 m 10 Spokes |  5.0 × 4.0 m 8 Spokes |  6.0 × 3.0 m 10 Spokes |  6.0 × 4.0 m 10 Spokes |  6.0 × 4.5 m 12 Spokes |
|------------------------------------------------------------------------------------------------|-------------------------------------------------------------------------------------------------------------|-------------------------------------------------------------------------------------------------------------|---------------------------------------------------------------------------------------------------------------|----------------------------------------------------------------------------------------------------------------|-----------------------------------------------------------------------------------------------------------------|---------------------------------------------------------------------------------------------------------------|----------------------------------------------------------------------------------------------------------------|----------------------------------------------------------------------------------------------------------------|----------------------------------------------------------------------------------------------------------------|
| All measurements are approximate | | | | | | | | | |
| Model No. | C 3340/20 | C 3340/30 | C 3350/25 | C 3350/30 | C 3350/375 | C 3350/40 | C 3360/30 | C 3360/40 | C 3360/45 |
| Area in m ² | 8 | 12 | 12.5 | 15 | 18.75 | 20 | 18 | 24 | 27 |
| Parasol weight <small>Without installation component & packaging, in kg</small> | 52 | 56 | 57 | 58 | 64 | 68 | 72 | 74 | 80 |
| Transport weight incl. packaging, in kg | 77 | 76 | 82 | 83 | 89 | 93 | 97 | 99 | 110 |
| A Height closed* in cm | 378 | 376 | 393 | 424 | 416 | 424 | 427 | 460 | 475 |
| B Height opened* in cm | 309 | 300 | 323 | 322 | 318 | 322 | 337 | 336 | 358 |
| C Passage height** in cm | 240 | 226 | 240 | 240 | 230 | 240 | 240 | 240 | 252 |
| D Ground clearance*** in cm | 110 | 111 | 95 | 93 | 92 | 64 | 80 | 56 | 86 |
| Max. permitted wind velocities <small>fully opened parasol, km/h Permanent/Mobile</small> | 88/66 | 88/66 | 74/56 | 74/56 | 74/56 | 74/56 | 50/38 | 50/38 | 50/38 |

* All measurements refer to the use with a permanent installation option (in-ground sleeve) ** For the edition with valance, the measurements reduce by 30 cm.



Jumbrella Wave

Jumbrella Wave is optically different to Jumbrella in that the membrane has a curved shape. This shape is reminiscent of an East Asian »Pagoda«. The technology in the Jumbrella Wave is principally identical. The difference lies in the extension of the tip of the parasol. This is what gives the parasol its curved look and visually sets it apart from other parasols. Jumbrella Wave – that special eye-catcher.

The Heart of it All

- ✿ 11 different model sizes from 9 to 36 m²
- ✿ Round and square models
- ✿ Maintenance-free servo mechanism for trouble-free opening and closing
- ✿ No loose functional parts like ropes, cranks or connectors
- ✿ Standard frame in traffic white | RAL 9016, glossy finish or in anthracite grey | RAL 7016, textured matte finish
- ✿ Optional custom design of frame finish (color, exclusive wood look | Golden Oak) and of membranes
- ✿ Membranes made of 100% polyester in three different high-quality fabrics
- ✿ Perfect, lasting tension as the textile membrane is integrated into the spokes
- ✿ Large, contemporary selection of colors
- ✿ Numerous possibilities for printing on the textile membranes and/or valances
- ✿ Great variety of additional features e.g. textile gutters, side panels, lighting with LED, heating, speakers, TV, Wifi
- ✿ Short delivery times, fast spare parts delivery lifelong spare parts supply
- ✿ Up to 111-months wind warranty depending on installation options and parasol size of up to max. wind force 10 | 102 km/h







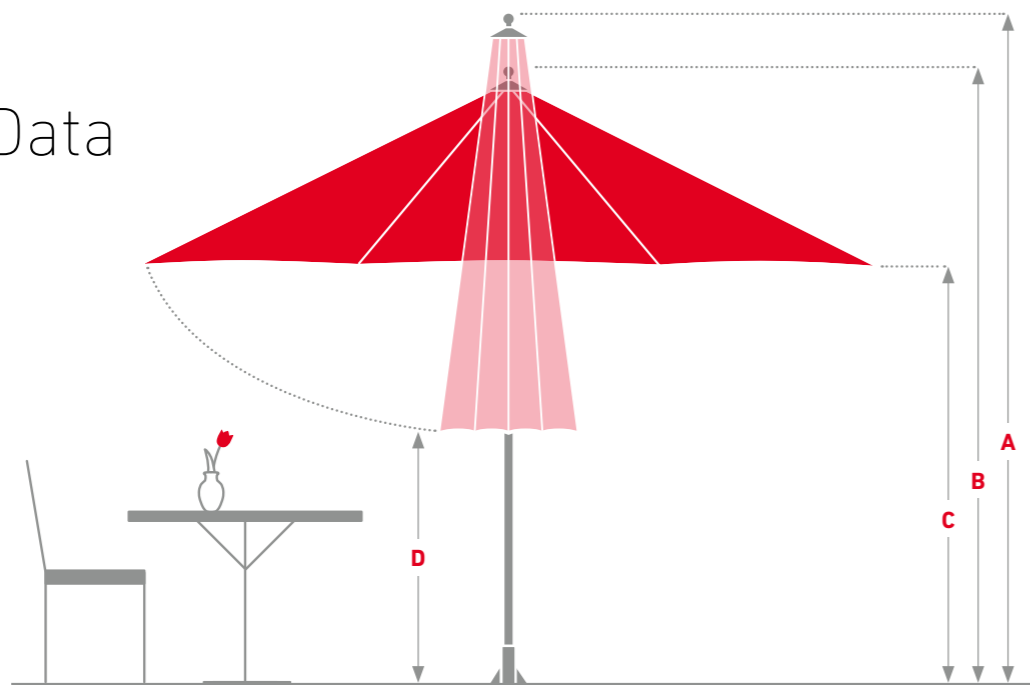

Dimensions & Technical Data

Jumbrella Wave



All measurements are approximate

| |  Ø 4.0 m 8 Spokes |  Ø 4.5 m 8 Spokes |  Ø 5.0 m 8 Spokes |  Ø 5.6 m 8 Spokes |  Ø 6.3 m 8 Spokes |  Ø 7.0 m 8 Spokes |
|------------------------------------------------------------------------------------------------|-------------------------------------------------------------------------------------------------------|-------------------------------------------------------------------------------------------------------|-------------------------------------------------------------------------------------------------------|-------------------------------------------------------------------------------------------------------|---------------------------------------------------------------------------------------------------------|---------------------------------------------------------------------------------------------------------|
| Model No. | A 3040 | A 3045 | A 3050 | A 3056 | A 3063 | A 3070 |
| Area in m ² | 12 | 15 | 19 | 24 | 29 | 36 |
| Parasol weight <small>Without installation component & packaging, in kg</small> | 41 | 46 | 60 | 71 | 78 | 105 |
| Transport weight <small>incl. packaging, in kg</small> | 61 | 66 | 80 | 91 | 103 | 130 |
| A Height closed* in cm | 393 | 410 | 411 | 423 | 455 | 470 |
| B Height opened* in cm | 345 | 363 | 366 | 382 | 421 | 445 |
| C Passage height** in cm | 227 | 234 | 234 | 235 | 248 | 258 |
| D Ground clearance** in cm | 160 | 148 | 121 | 113 | 113 | 113 |
| Max. permitted wind velocities <small>fully opened parasol, km/h Permanent/Mobile</small> | 84/59 | 84/59 | 80/56 | 74/52 | 48/34 | 38/27 |

All measurements are approximate

| |  3.0 x 3.0 m 8 Spokes |  3.53 x 3.53 m 8 Spokes |  4.0 x 4.0 m 8 Spokes |  4.5 x 4.5 m 8 Spokes |  5.0 x 5.0 m 8 Spokes |
|------------------------------------------------------------------------------------------------|-------------------------------------------------------------------------------------------------------------|---------------------------------------------------------------------------------------------------------------|-------------------------------------------------------------------------------------------------------------|---------------------------------------------------------------------------------------------------------------|---------------------------------------------------------------------------------------------------------------|
| Model No. | A 3130 | A 3135 | A 3140 | A 3145 | A 3150 |
| Area in m ² | 9 | 12 | 16 | 20 | 25 |
| Parasol weight <small>Without installation component & packaging, in kg</small> | 45 | 49 | 56 | 63 | 90 |
| Transport weight <small>incl. packaging, in kg</small> | 65 | 69 | 76 | 88 | 115 |
| A Height closed* in cm | 398 | 404 | 398 | 385 | 428 |
| B Height opened* in cm | 334 | 355 | 344 | 311 | 393 |
| C Passage height** in cm | 234 | 236 | 236 | 236 | 245 |
| D Ground clearance** in cm | 155 | 124 | 85 | 56 | 40 |
| Max. permitted wind velocities <small>fully opened parasol, km/h Permanent/Mobile</small> | 92/67 | 84/59 | 80/56 | 74/52 | 70/49 |

* All measurements refer to the use with a permanent installation option (in-ground sleeve) ** For the edition with valance, the measurements reduce by 30 cm.

Good to know

Sustainability and Environmental Compatibility

The betex®05 fabric, exclusively crafted for Bahama, and the resulting textile membrane are certified exclusively according to the OEKO-TEX 100 standard, Class 1 which is awarded by independent institutions. Class 1 meets the demands of baby clothing with skin contact.

The OEKO-TEX pollutant test corresponds to the respective intended use of the textiles and materials. In Germany there are clear and reliable criteria for environmental compatibility and sustainability. Bahama demands of its products that every defect or damaged part can be replaced.

Made in Germany

Bahama's customers always refer back to the great importance of our German production facilities. »Made in Germany« is still a unique selling point and a reason to buy. Bahama's full range production facility is located in Germany.

The combination of the highest quality materials and structural features allows Bahama to guarantee the wind stability of its products, depending on the model, up to 130 km/h. In addition to the technical details of the parasol, it is especially the lightfastness of the fabrics' colors, the water-proofness and grammage as well as the water column of the textile membranes which make Bahama top of its class. Trust is placed in Bahama by luxury hotels such as the Burj Al Arab in Dubai, the Hotel Sacher in Vienna and the Dalí Museum in St. Petersburg, USA.



Service

Service greatly influences the life span of a parasol. The exchangeable textile membrane of a Bahama parasol can – after being exposed to all sorts of weather conditions for years – be cleaned or replaced. Our service makes a full technical and general overhaul of the product such that they not only look attractive, but can defy the strongest of winds.

No matter where you need Bahama's service, the Bahama team or one of our expert partners will be glad to help – worldwide.

Careful and individual planning

Installation of new parasols

Fitting of new textile membranes

Complete service i.e. assembling and disassembling the large parasols, washing, cleaning and maintenance of the frame and textile membranes

Membrane service, i.e. fitting and removing the textile membrane, cleaning and repairing

Storage of the returned and serviced large parasols and/or textile membranes

Technical trainings

UV-Protection

Analogous to the sun protection factor/SPF all textiles are labeled with an ultraviolet protection factor/UPF. Built into the fabric it protects against hazardous UV radiation. Bahama uses the fabric brand betex®05 for the production of its parasol textile membranes. This material fulfills the requirements for UPF50+, which indicates an »excellent« dermatological UV protection factor according to DIN EN 13758 and allows less than one fiftieth (<2%) of the UV radiation through the textile membrane onto the skin.





05/2018

BAHAMA®